

TSS-WS



Product Description

The TSS-WS smart socket enables you to easily control your appliance with your smartphone, tablet or virtual assistants Google Home and Amazon Alexa.

Technical Specification

Controller	TSS-WS
Panel material	Tempered glass
Voltage Rating	AC 100-250V 50-60Hz
Current Rating	10A
Load Rating	2200W
Standby power	0.25W
Wi-Fi standard	802.11b/g/n (2.4 GHz)
Wi-Fi Security	WEP/WPA/WPA2 (AES-TKIP-Personal)
Wi-Fi performance Transmission power	+20dBm,11Mbps(CCK)
Wi-Fi performance Re- ceiver sensitivity	-89dBm,11Mbps(CCK)W
Size	85x85x32mm
Weight	0.3kg
Operating temperature	-25 °C to + 60 °C
Relative humidity	< 95%

Features

- No hub, bridge or gateway required
- Mobile app and voice control
- Compatible with Google Home and Amazon Alexa
- Timer function
- Scene settings
- Backlight LED indicator

Controller layout

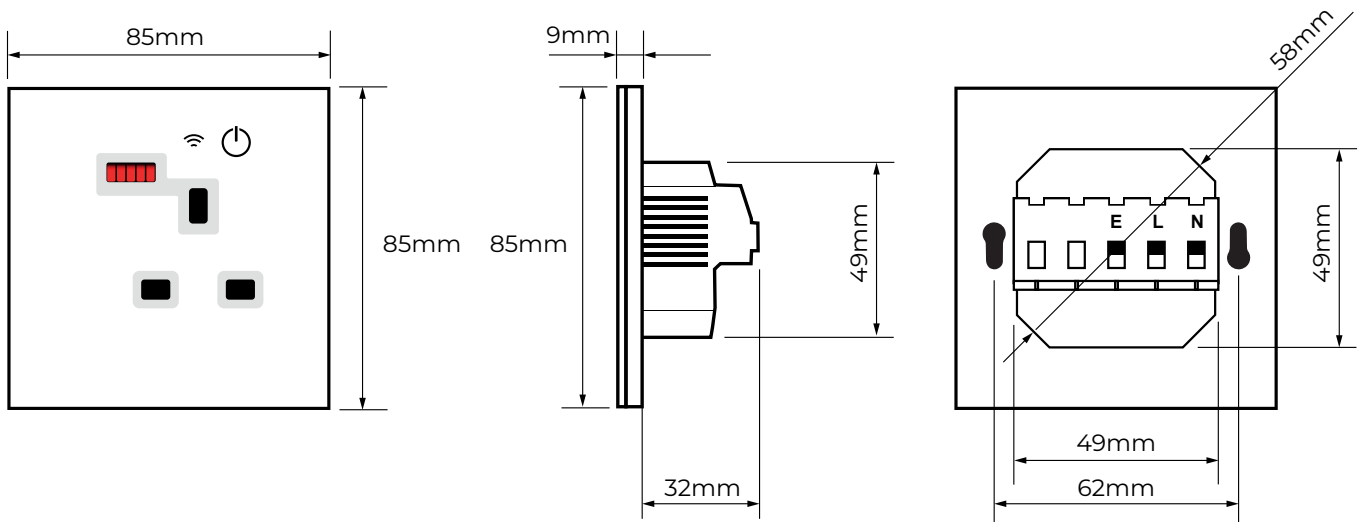
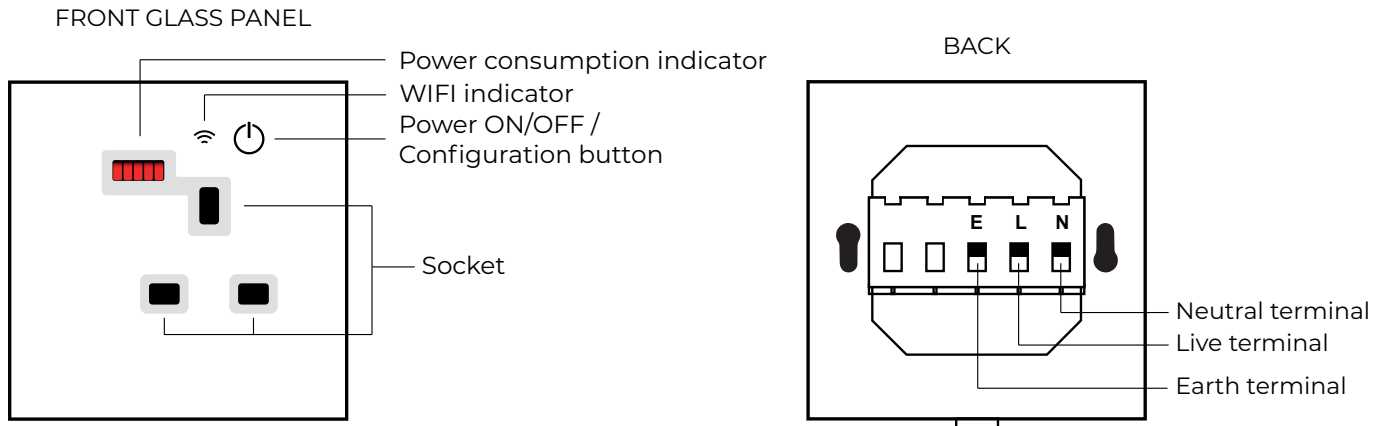

Installation diagram

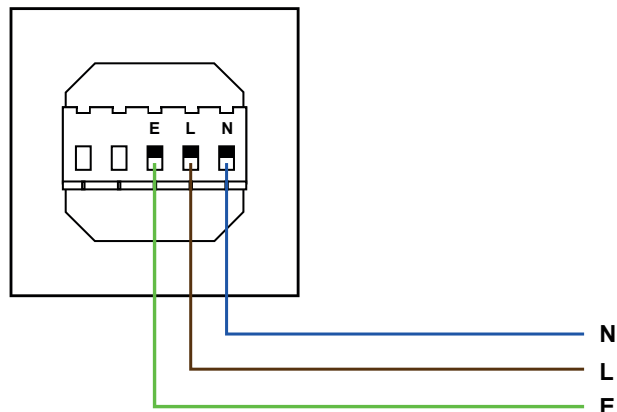

Smart WIFI socket

INTALED

Downloading the mobile app and creating the account

1) Search and install “**Lanbon Smart Living**” app from the Google Play store or iOS AppStore.



2) Select Area “Europe”.

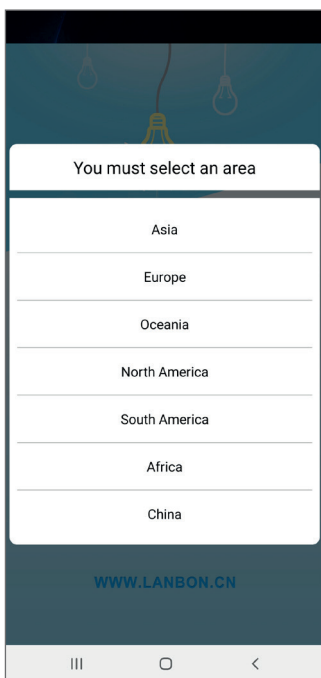

3) Create account by pressing the profile icon in the top left corner.

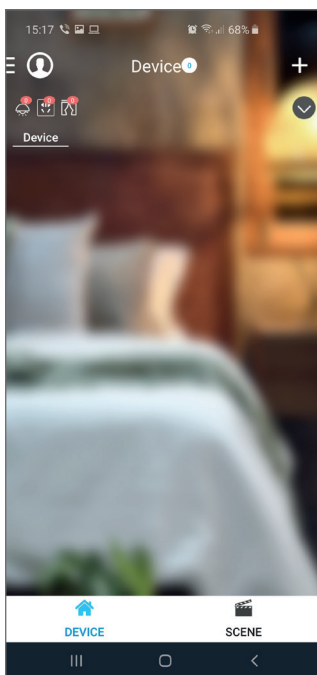

4) Press More button at the bottom of the app.

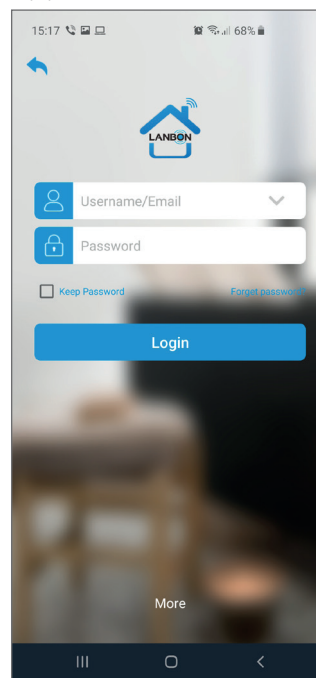

Smart WIFI socket

INTALED

5) Press Sign up.

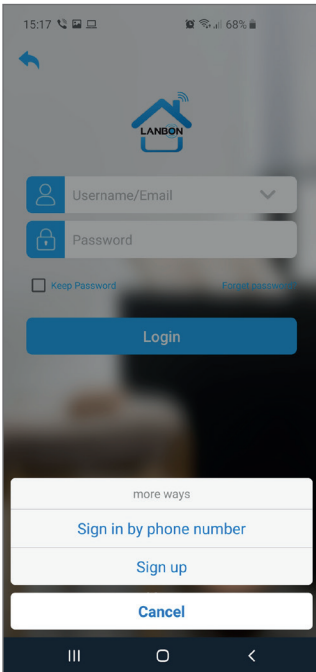

6) Choose username. This can be your email.

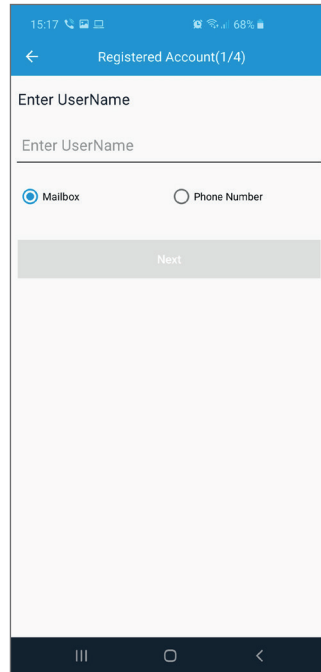

7) Enter your email address.

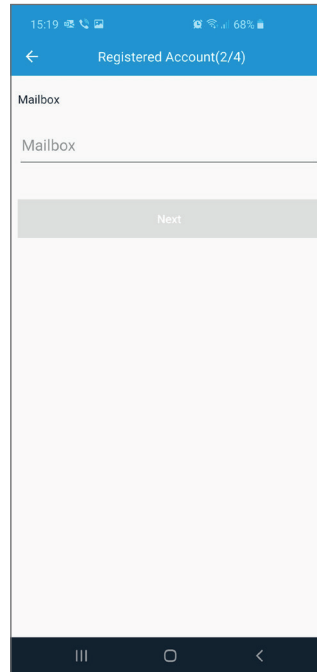

8) Enter your verification code you have received on your email.

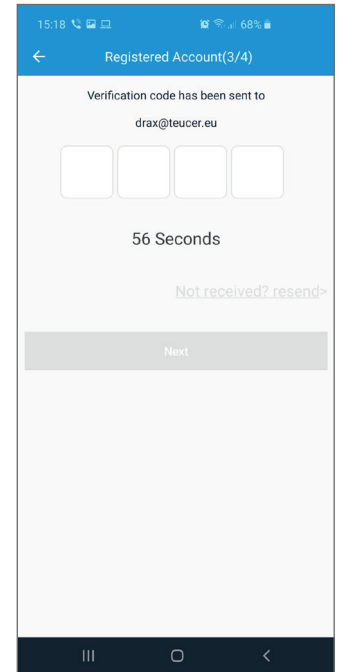

9) Choose the password.

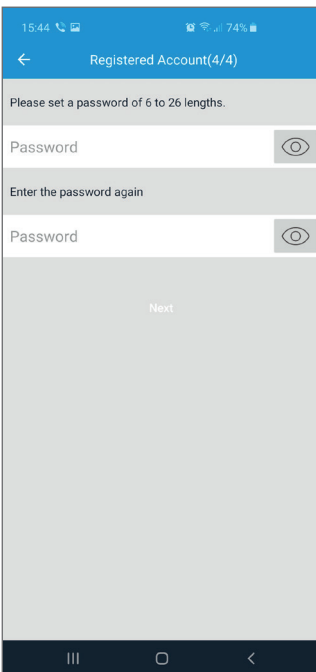

10) Login with your email and password.

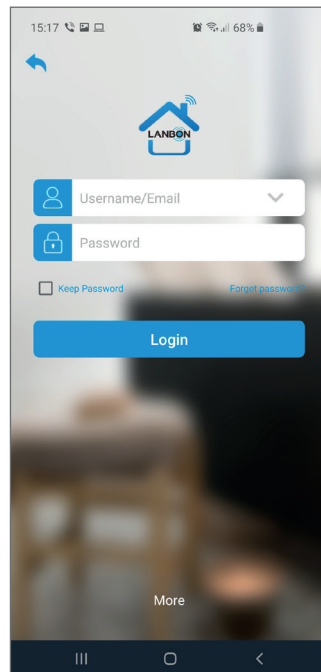

11) Check you have logged in by pressing the top left profile icon.

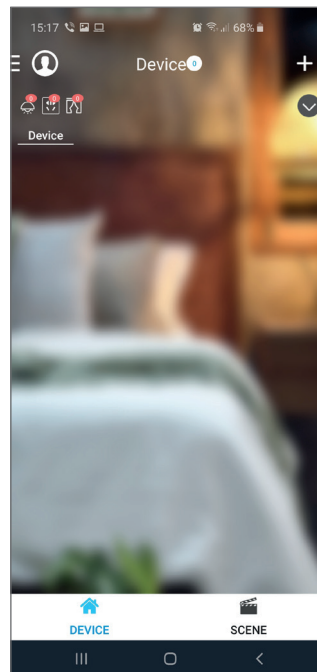

You should see your username next to the top left profile icon.

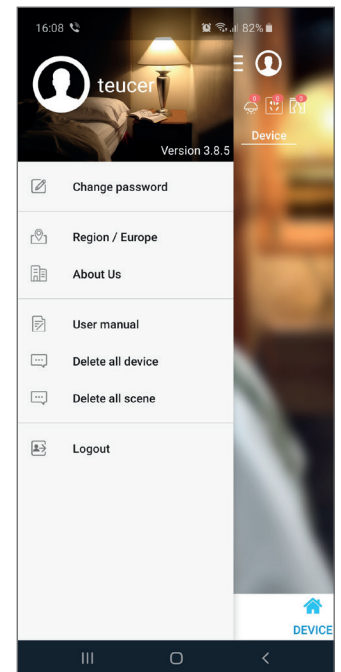

Connecting the smart WIFI socket to your Home WIFI network

- 1) Make sure you have connected your phone to your home WIFI network. This product supports only 2.4Ghz 802.11b/g/n mode.
- 2) Press and hold configuration button for more than 5 seconds until you hear chime and see WIFI indicator starts flashing rapidly.

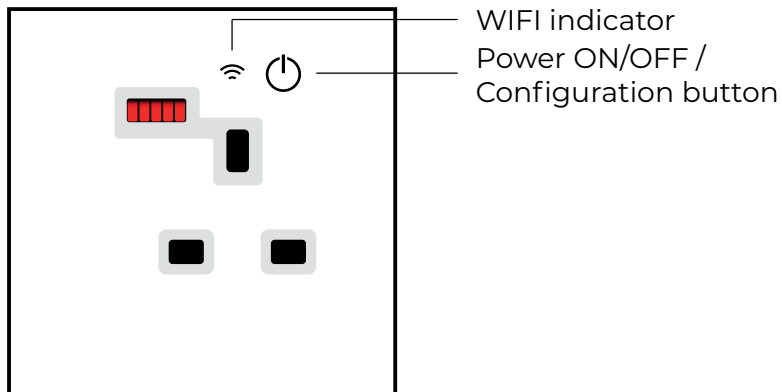

3) Press the + in the top right corner to add switch.

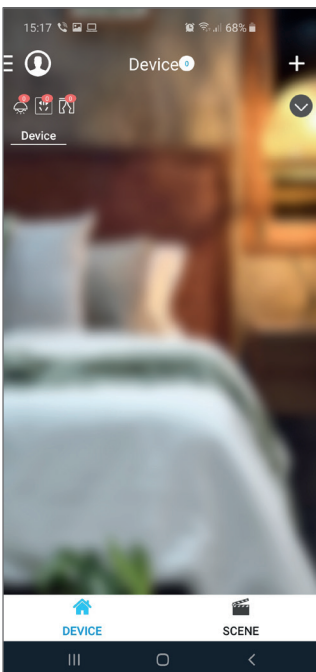

4) Select L6 System.

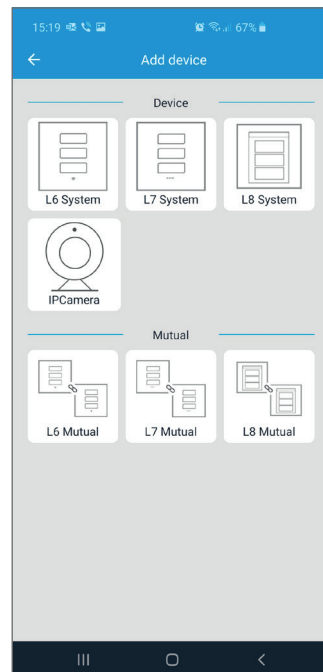

5) Enter your home network WIFI password.

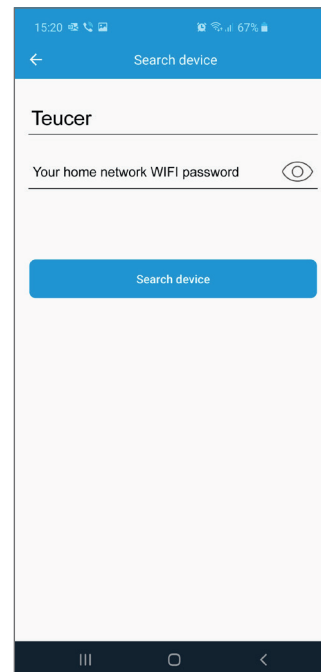

6) Wait for process finish. You should see socket icon pop up.

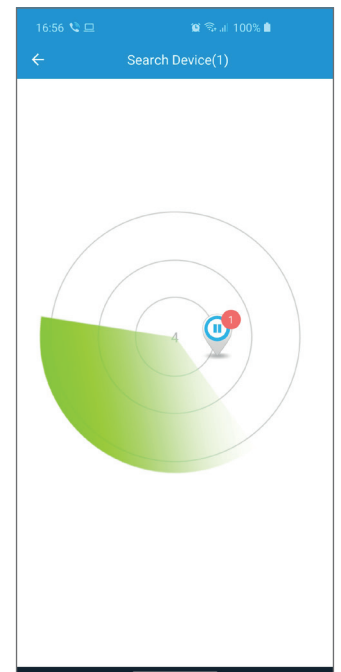

7) Once the process has finished you will see the smart WIFI switch on the main app screen. Default name is Socket.

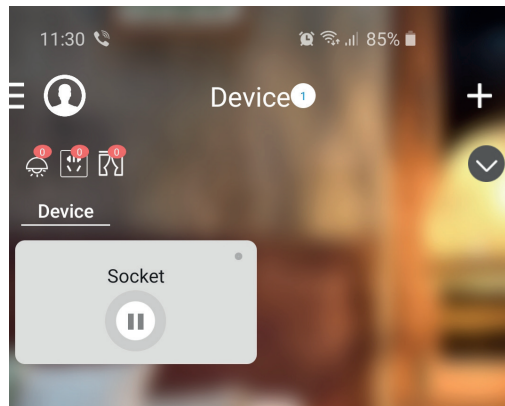

Controlling the smart WIFI socket

Press the socket icon to switch the appliance ON/OFF. By pressing the white background around the socket icon you will open the socket control screen.

Press the socket icon to switch ON/OFF.

By pressing the Gear icon in the top right corner, you will open the smart WIFI socket settings.

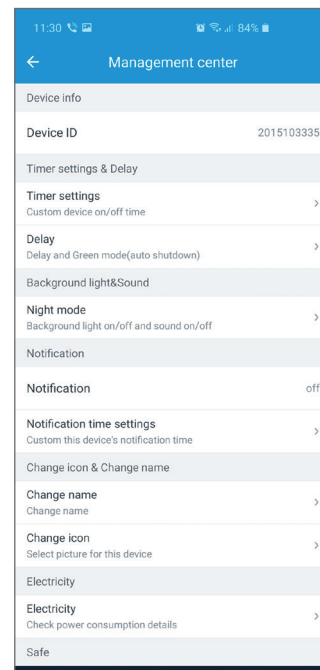
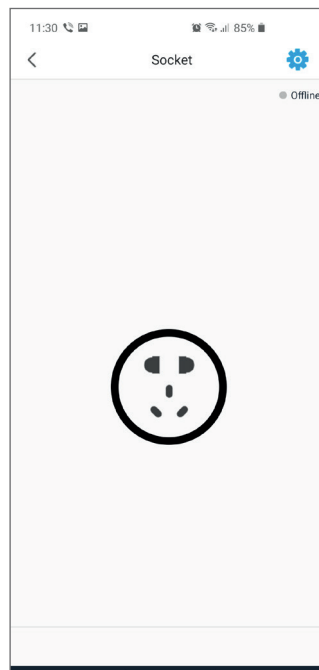
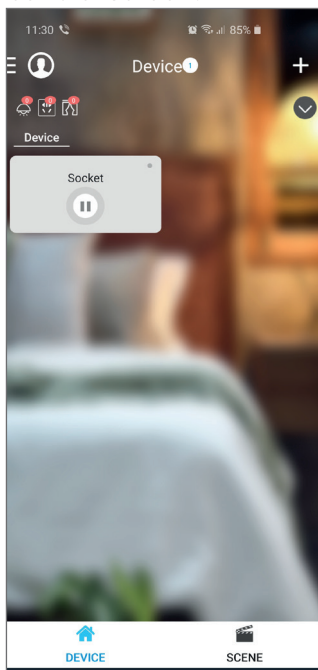

Smart WIFI socket

INTALED

Smart WIFI socket settings

Timer Settings

You can set up to 4 different recurring timers.

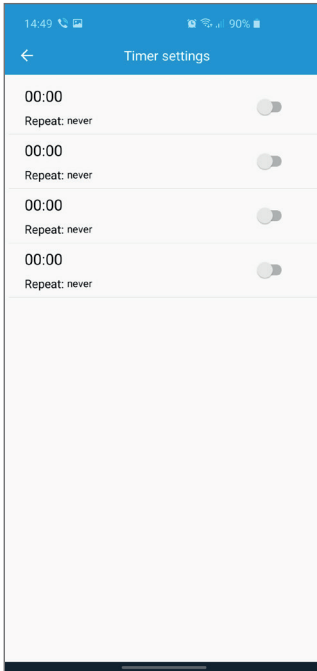

Night Mode

Night mode turns OFF the sound. It can be scheduled.

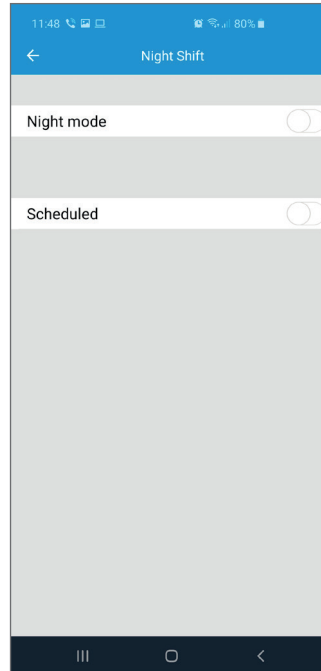

Notification

By turning ON notification, you can get the notification every time socket is turned ON/OFF.

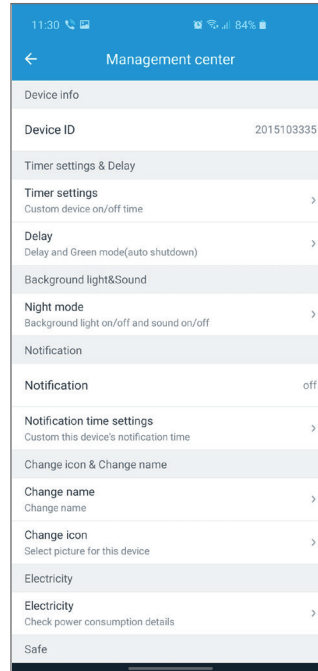

Change name

You can rename the socket. Voice control will use this name to control.

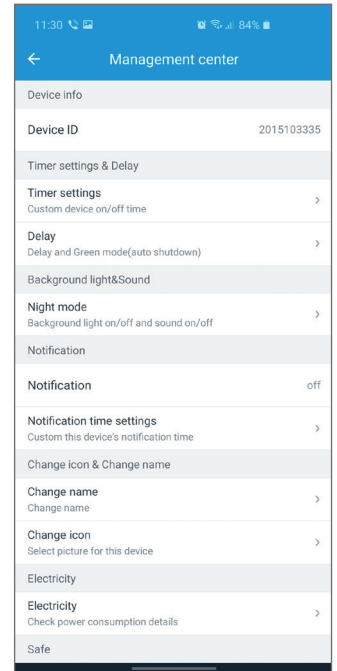

Factory reset or Delete

You can reset the smart WIFI socket to the factory defaults or delete device from the app.

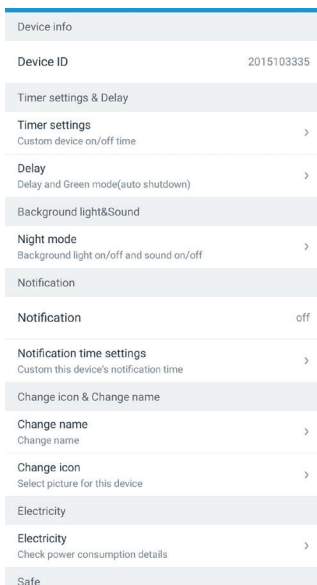

Connecting the smart WIFI socket to Google Home.

Note! Make sure you have paired smart WIFI socket with the mobile app.

1) Press the + in the top left corner to add the group.

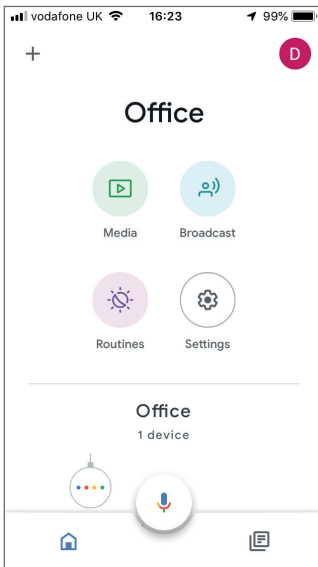

2) Press Set up device.

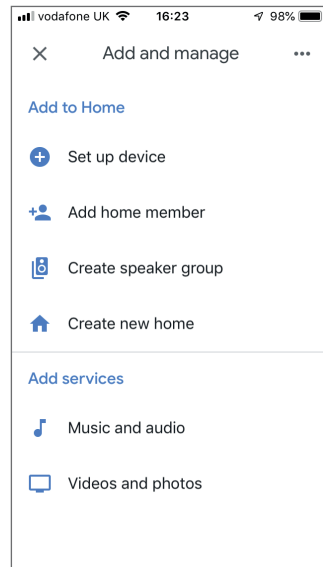

3) Choose "Have something already set up?".

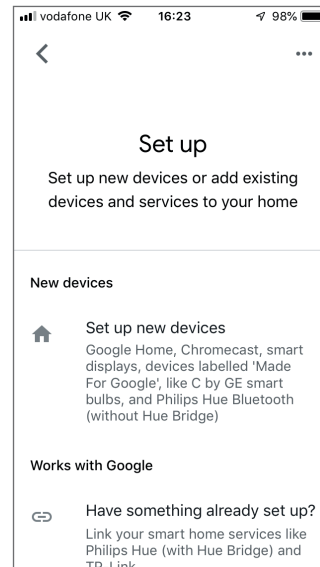

4) Choose your home.

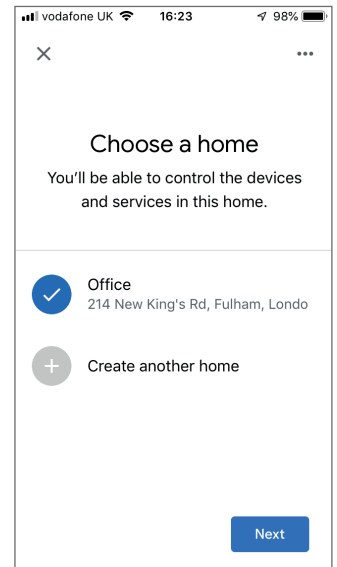

5) Search and select Lanbon Smart Living.

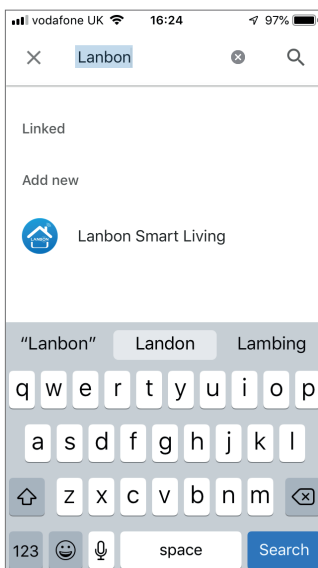

6) Login with your lanbon credentials.

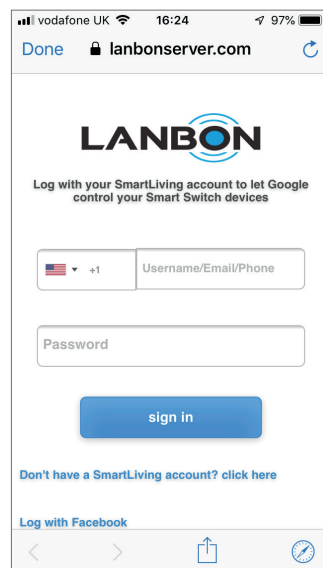

7) You will see the message "Lanbon Smart Living is now linked".

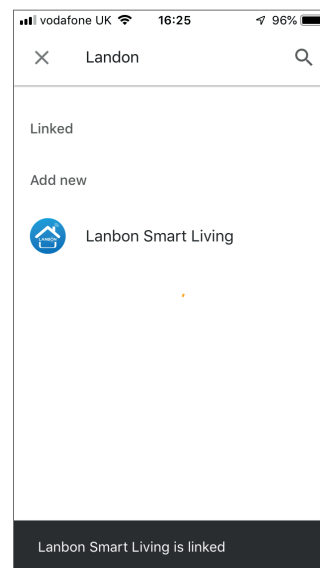

8) Now you can assign the smart WIFI socket to a room and start using with Google Home.

You can say "Hey Google, turn on the bedside lamp" if you have assigned the switch to the bedroom bedside light socket.

For more information how to use voice commands please refer to the Google Home user manual.

Connecting the smart WIFI socket to Amazon Alexa.

Note! Make sure you have paired smart WIFI socket with the mobile app.

- 1) Open the Alexa app on your smartphone and go to Skills & Games.
- 2) In the top right corner Search for the “Lanbon Smart Living” skill and enable.
- 3) Login with your Lanbon credentials.
- 4) You have now linked Amazon Alexa with Lanbon.

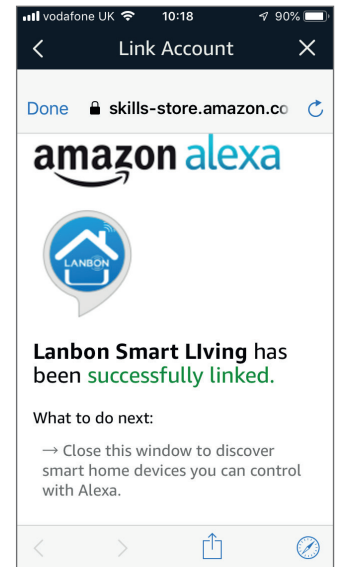
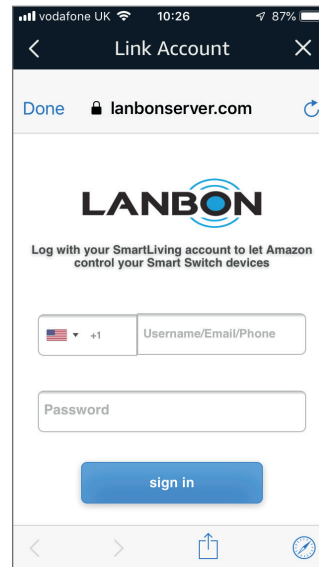
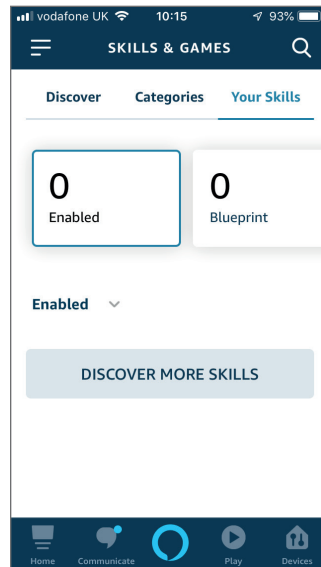
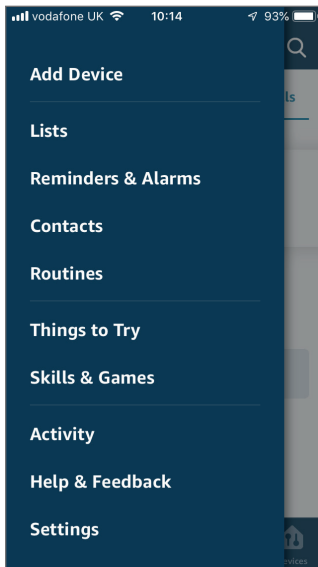

You can say “Alexa, turn on bedside lamp” if you have assigned the name to “Bedside lamp”.

For more information how to use voice commands please refer to the Amazon Alexa user manual.

Smart WIFI socket

INTALED

Problem	Cause	Corrective
Unable to switch ON/OFF (No indicator light)	<ul style="list-style-type: none">• No power.• Wrong connection or unsecure connection.	<ul style="list-style-type: none">• Check the power.• Check the connection.
Cannot connect switches to WIFI	<ul style="list-style-type: none">• Trying to connect to 5Ghz (802.11ac)	<ul style="list-style-type: none">• Connect to 2.4GHz home network (802.11b/g/n)

Safety

- Products must be installed and serviced by qualified electrician.
- Never install product whilst connected to power and double check connections before switching on to avoid short circuits.
- Ensure all terminal screws are fully tightened and product is securely fixed to its mounting box prior to turning on the mains supply.

Guarantee:

All LED and electrical components carry a 5 year electrical guarantee, All lamps have their own average life span. We recommend all products are installed by NICEIC / registered electrical contractors, failure to do so will result in any guarantee becoming void.

Full Terms & Conditions:

For our full terms and conditions please visit our website - www.intalite.co.uk/terms-conditions

INTALITE UK
148 - 154 Merton High Street;
London, SW19 1AZ, UK
Tel: +44 (0)20 8542 1471
Fax: 0870 4211 763
www.intalite.co.uk
sales@intalite.co.uk