

# Smart WIFI switch

3 Gang

# INTALED

## TSS-3G



### Product Description

The TSS-3G smart switch enables you to easily control your lights with your smartphone, tablet or virtual assistants Google Home and Amazon Alexa.

### Technical Specification

Controller	TSS-3G
Panel material	Tempered glass
Voltage Rating	AC 100-250V 50-60Hz
Load Rating	3x200W
Standby power	0.25W
Wi-Fi standard	802.11b/g/n (2.4 GHz)
Wi-Fi Security	WEP/WPA/WPA2 (AES-TKIP-Personal)
Wi-Fi performance Transmission power	+20dBm,11Mbps(CCK)
Wi-Fi performance Receiver sensitivity	-89dBm,11Mbps(CCK)W
Size	85x85x32mm
Weight	0.3kg
Operating temperature	-25 °C to + 60 °C
Relative humidity	< 95%

### Features

- 3 Gang switch with 3x200W of maximum load
- No hub, bridge or gateway required
- Mobile app and voice control
- Compatible with Google Home and Amazon Alexa
- Timer function
- Scene settings
- Backlight LED indicator
- 2 way switching wirelessly
- Requires neutral wire to operate

# Smart WIFI switch

3 Gang

# INTALED

## Controller layout

DETACHABLE  
FRONT GLASS PANEL

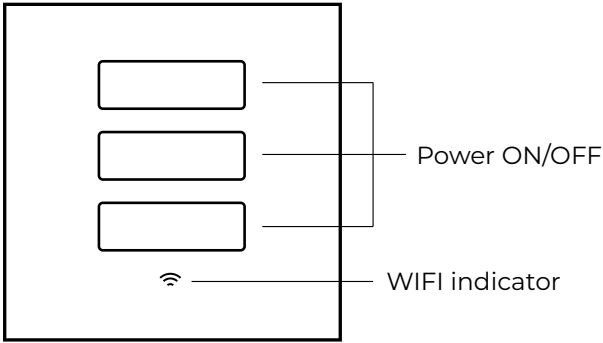

FRONT

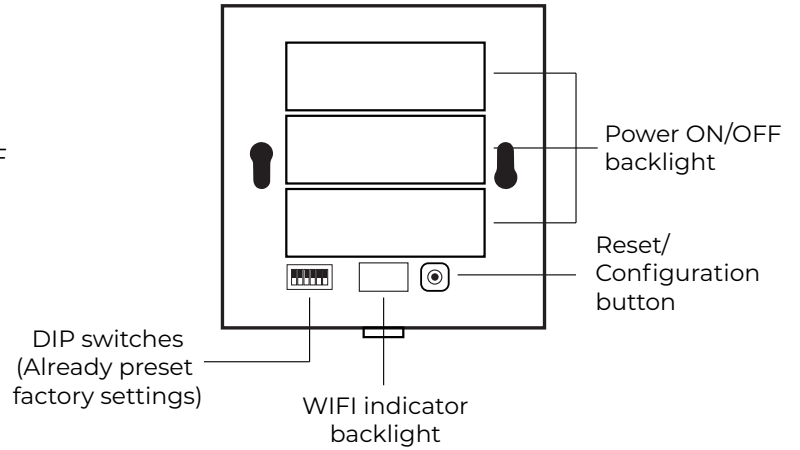

BACK

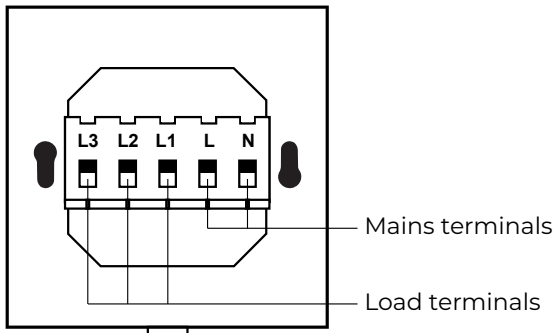

FRONT PANEL  
REMOVAL

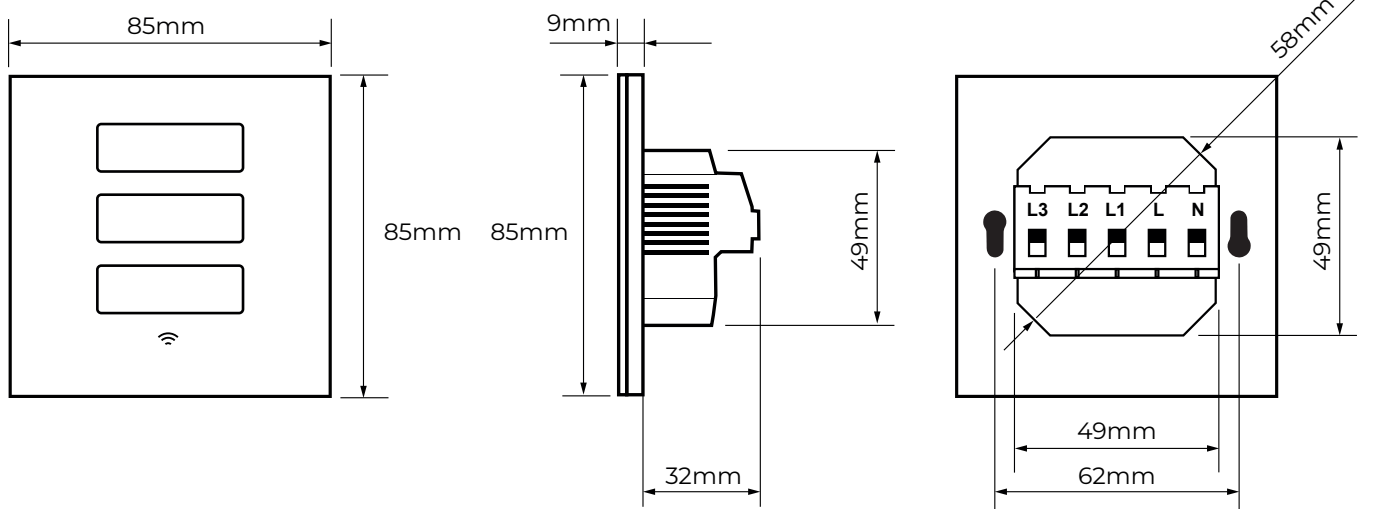
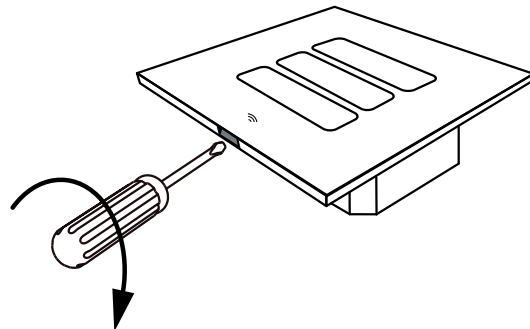

# Smart WIFI switch

3 Gang

# INTALED

Installation diagram (one-way setup)

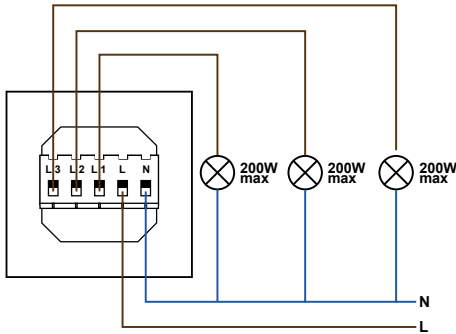

Installation diagram (two-way setup)

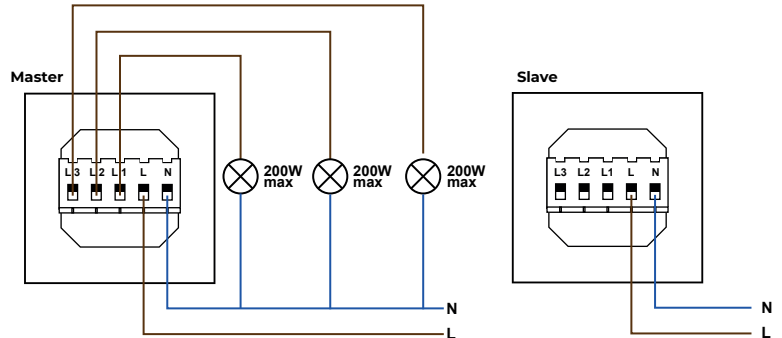

Note! This product requires a **neutral wire** to operate.

Each switch should always be installed as a “one-way” setup. In a two-way setup, slave switch will be connected separately to mains and grouped wirelessly to the master inside the mobile app.

## Downloading the mobile app and creating the account

1) Search and install “**Lanbon Smart Living**” app from the Google Play store or iOS AppStore.



2) Select Area “Europe”.

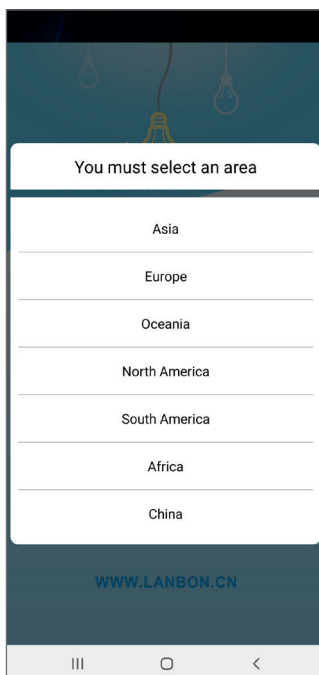

3) Create account by pressing the profile icon in the top left corner.

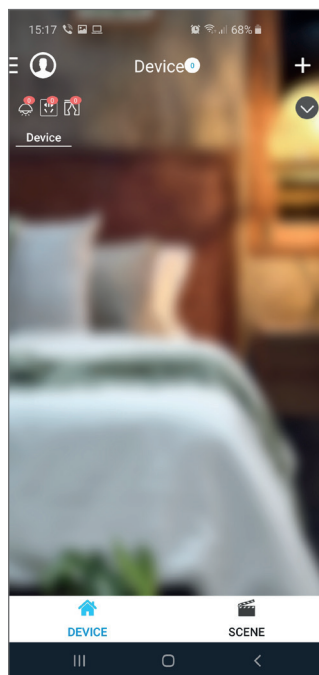

4) Press More button at the bottom of the app.

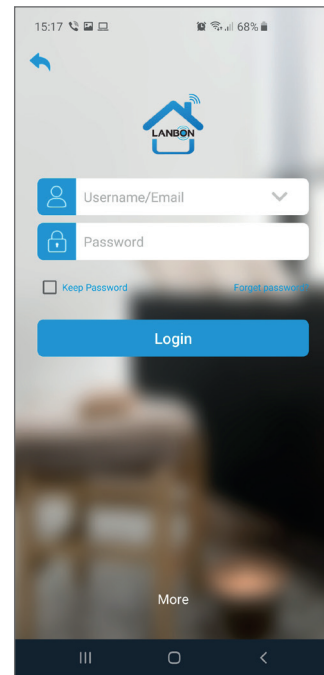

# Smart WIFI switch

3 Gang

# INTALED

5) Press Sign up.

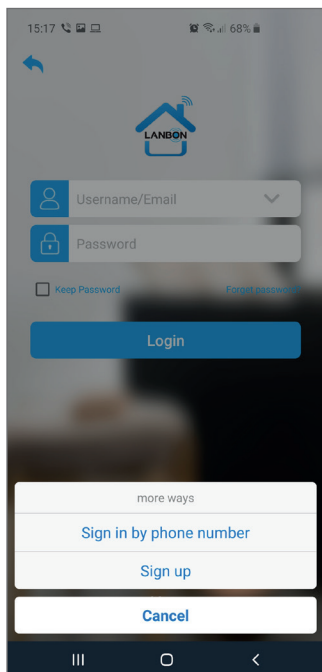

6) Choose username. This can be your email.

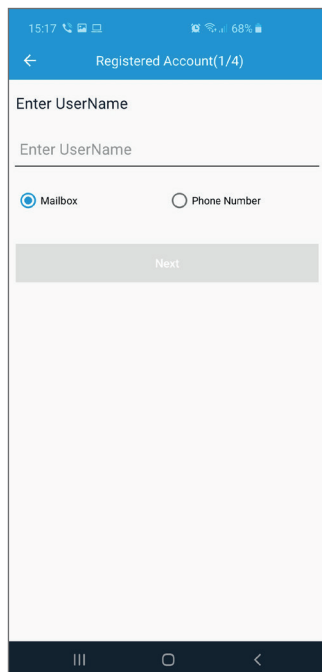

7) Enter your email address.

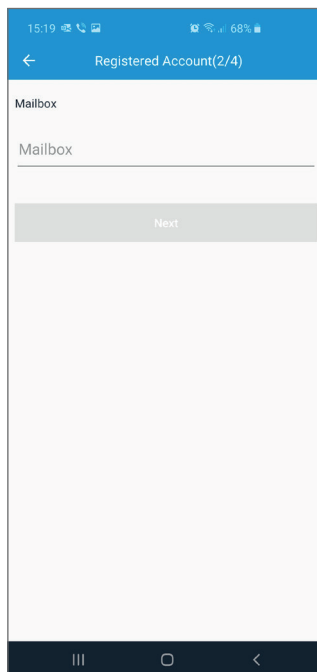

8) Enter your verification code you have received on your email.

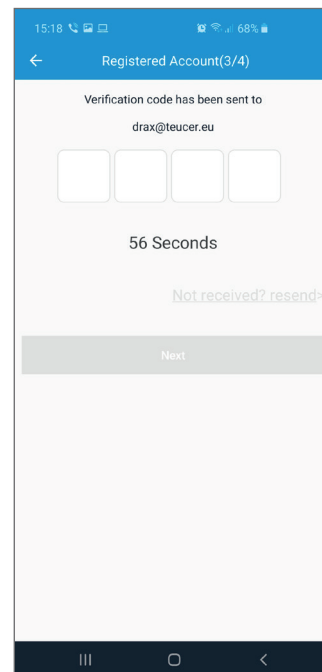

9) Choose the password.

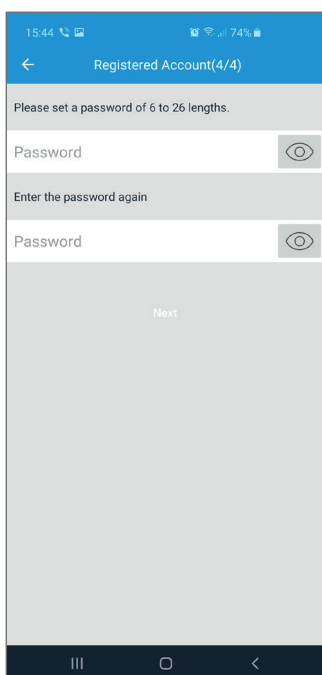

10) Login with your email and password.

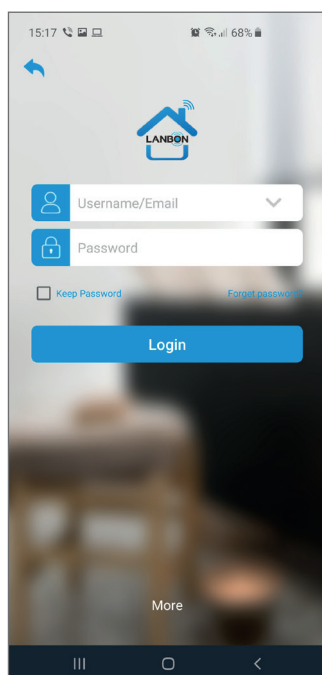

11) Check you have logged in by pressing the top left profile icon.

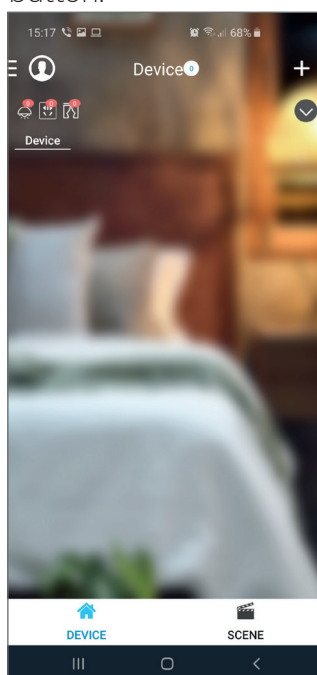

You should see your username next to the top left profile icon.

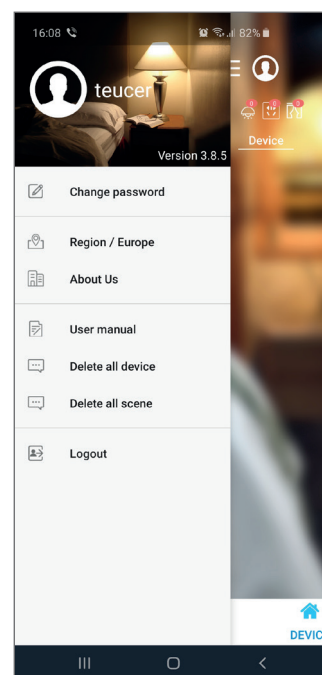

# Smart WIFI switch

3 Gang

# INTALED

## Connecting the smart WIFI switch to your Home WIFI network

- 1) Make sure you have connected your phone to your home WIFI network. This product supports only 2.4Ghz 802.11b/g/n mode.
- 2) Remove the front plate using a flat head screwdriver.

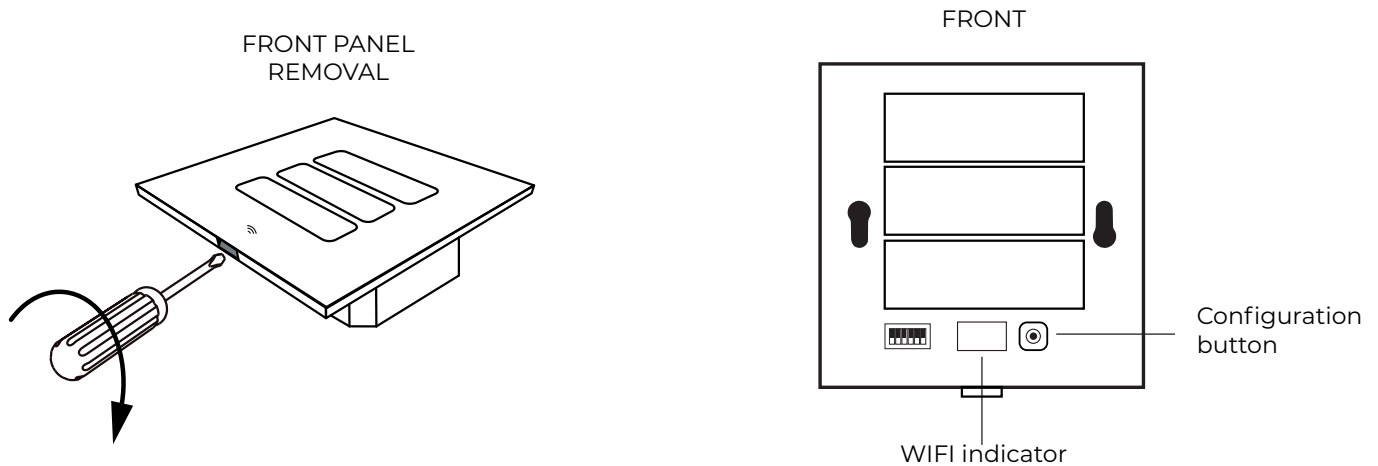

- 3) Press and hold configuration button for more than 5 seconds until you hear chime and see WIFI indicator starts flashing rapidly.

- 4) Press the + in the top right corner to add switch.

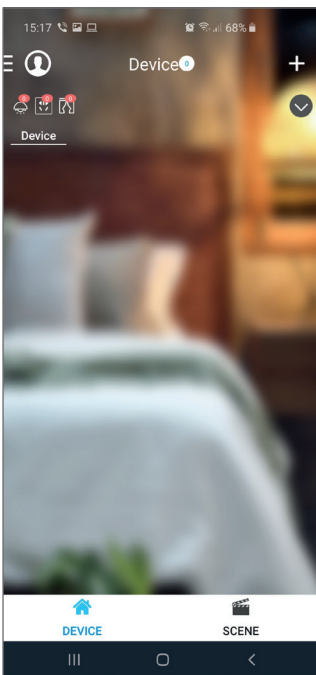

- 5) Select L6 System.

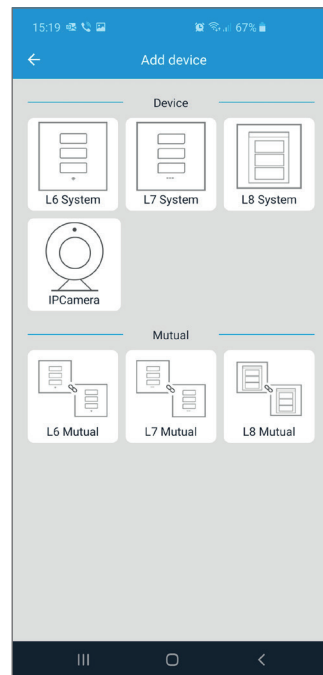

- 6) Enter your home network WIFI password.

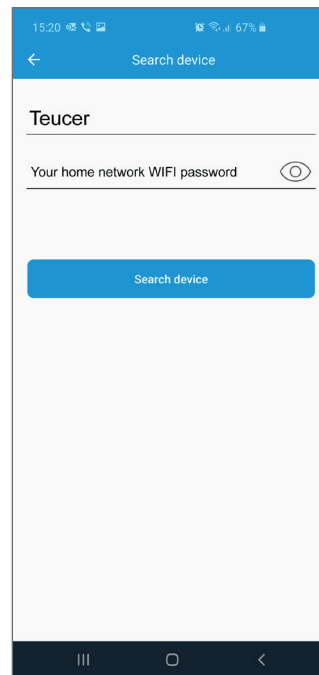

- 7) Wait for process to finish. You should see light icon pop up.

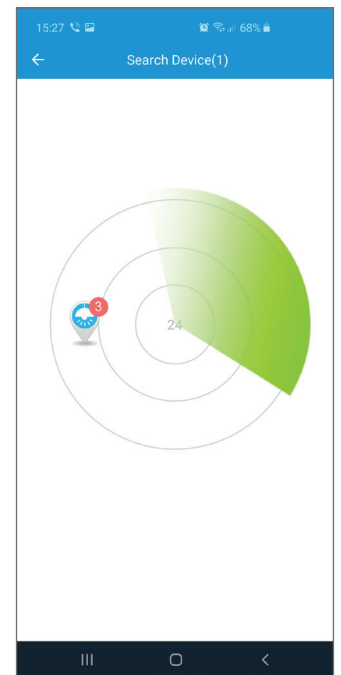

# Smart WIFI switch

## 3 Gang



8) Once the process has finished you will see the smart WIFI switch on the main app screen. Default name is Light.

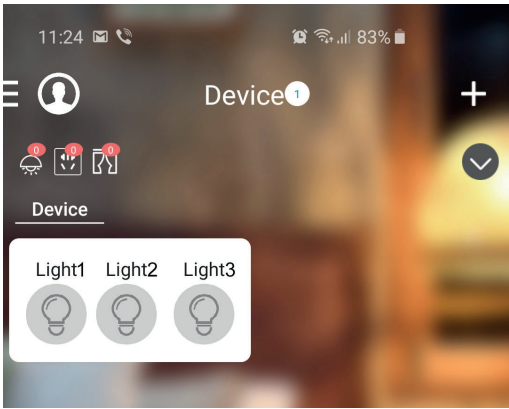

### Controlling the smart WIFI switch

Press the light bulb icon to switch the lights ON/OFF. By pressing the white background around the light bulb icon you will open the light control screen.

Press the light icon to switch ON/OFF.

By pressing the Gear icon in the top right corner, you will open the smart WIFI switch settings.

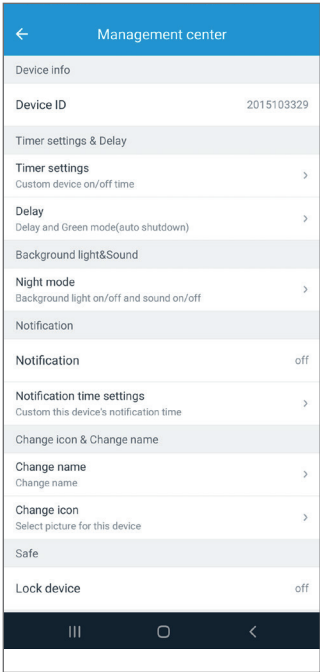
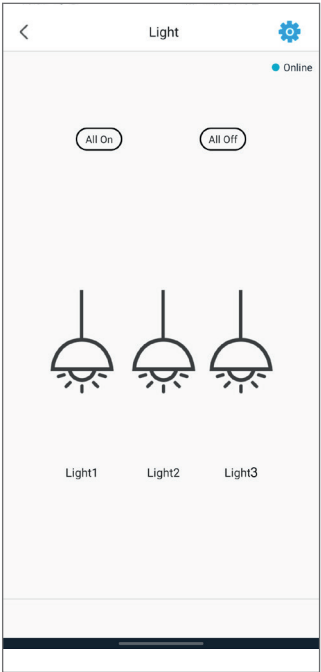
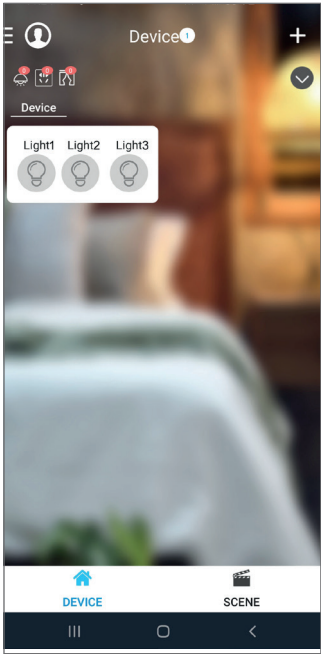

# Smart WIFI switch

3 Gang

# INTALED

## Smart WIFI switch settings

### Timer Settings

You can set up to 4 different recurring timers.

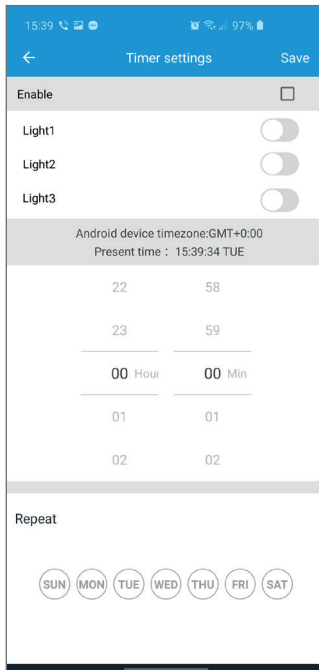

### Delay/Green Mode

**Delay:** Set the delay in minutes and lights will switch ON/OFF from the time you press save.

**Green Mode:** Set the auto shut down time and the light will switch OFF every time after preset time.

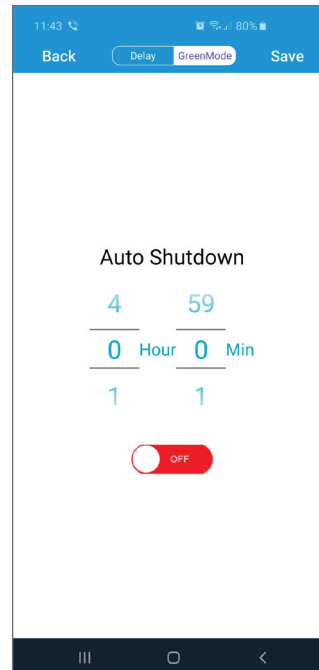
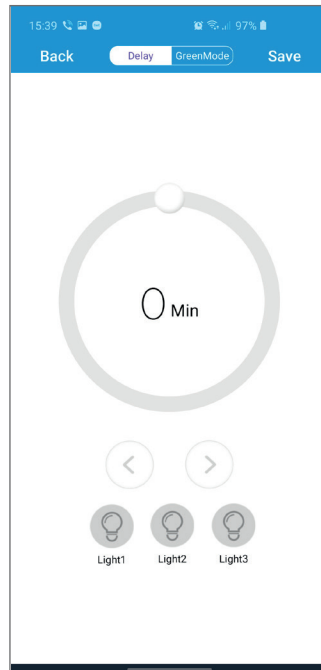

### Night Mode

Night mode turns OFF background LED Indicator. It can be scheduled.

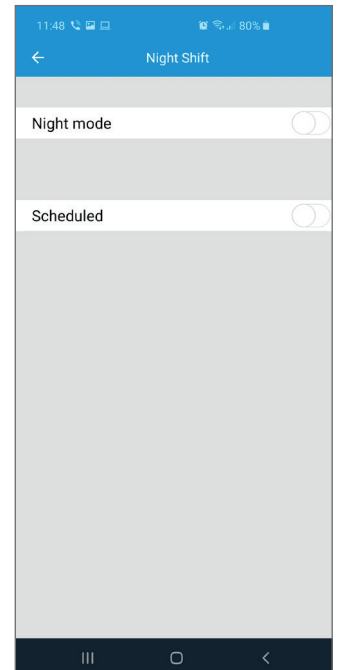

### Notification

By turning ON notification, you can get the notification every time switch is turned ON/OFF.

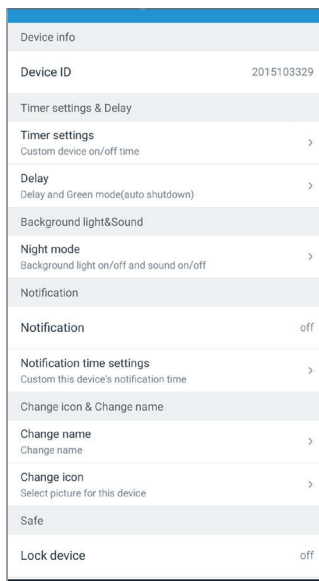

### Change name

You can rename the light to represent where switch has been installed. Voice control will use this name to control.

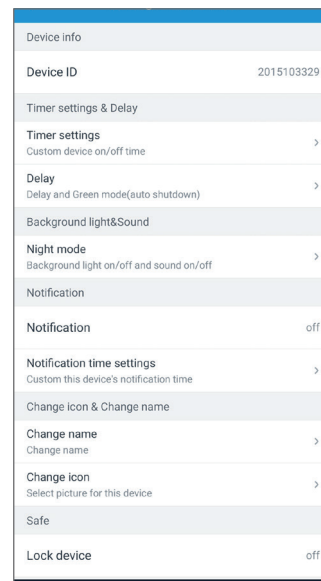

### Factory reset or Delete

You can reset the smart WIFI switch to the factory defaults or delete device from the app.

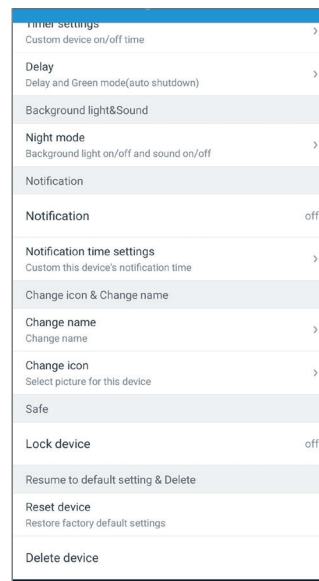



# Smart WIFI switch

3 Gang

# INTALED

## Connecting two smart WIFI switches in a two-way setup

1) Make sure you have paired both smart WIFI switches with the mobile app.

2) Press the + in the top right corner to group the switches.

3) Select L6 mutual from the bottom of the screen.

4) Press the + in the top right corner to add the group.

5) Select Switch

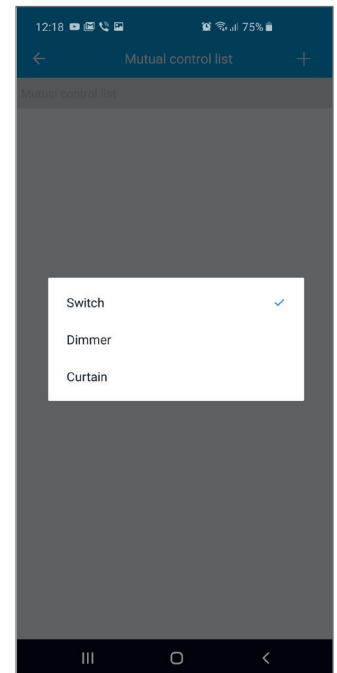
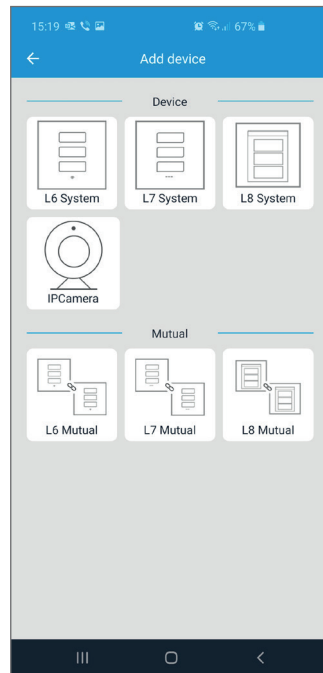
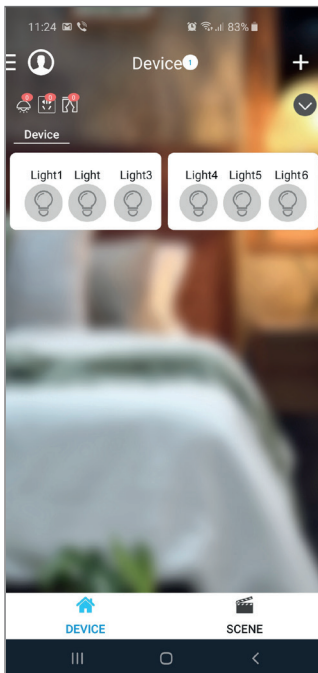

6) Select Switch

7) Choose the mutual group name

8) Select the lights/switches you wish to group and press Save.

Now you can control the grouped light with both switches at the same time.

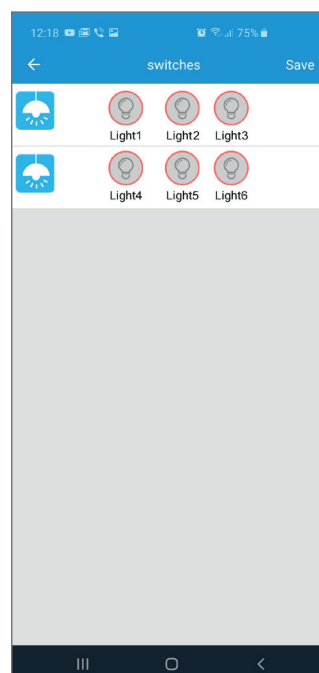
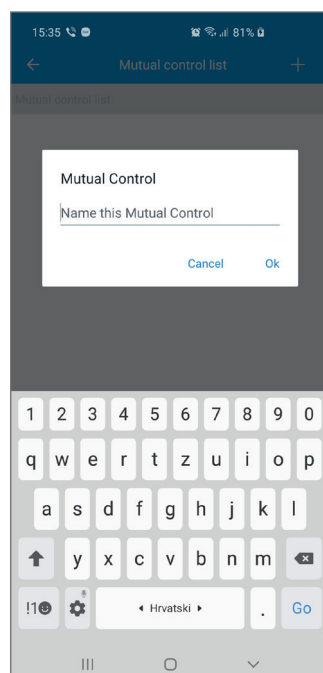
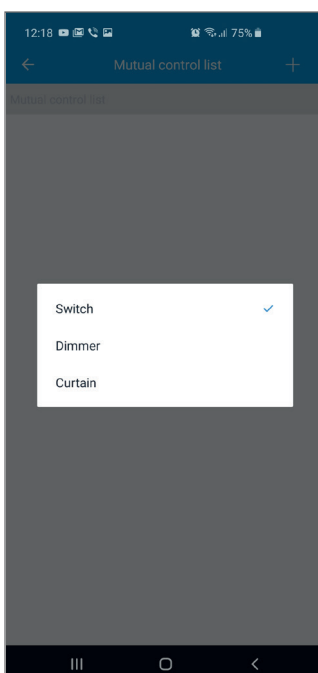



# Smart WIFI switch

3 Gang

# INTALED

## Connecting the smart WIFI switches to Google Home.

Note! Make sure you have paired smart WIFI switch with the mobile app.

1) Press the + in the top left corner to add the group.

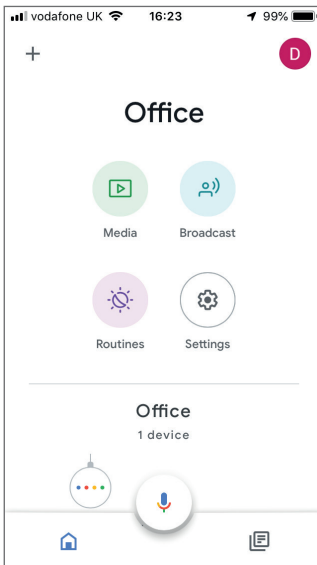

2) Press Set up device.

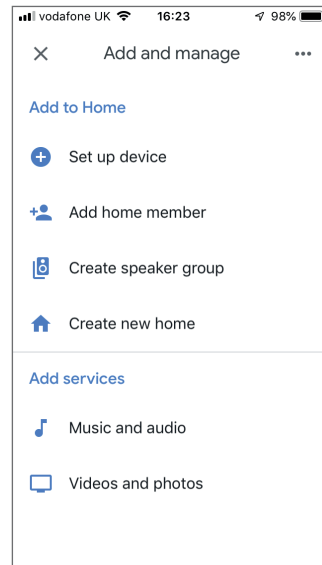

3) Choose "Have something already set up?".

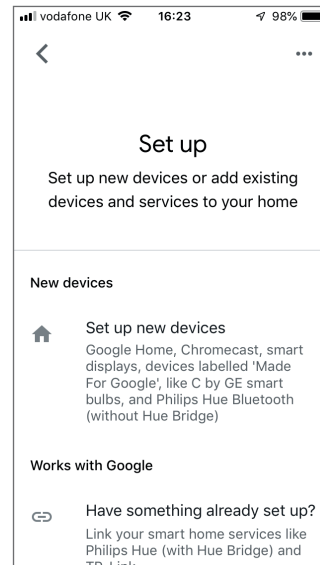

4) Choose your home.

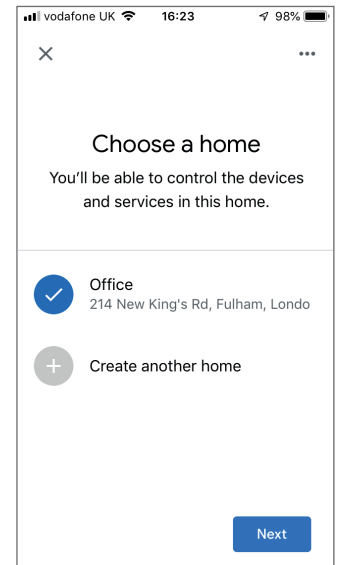

5) Search and select Lanbon Smart Living.

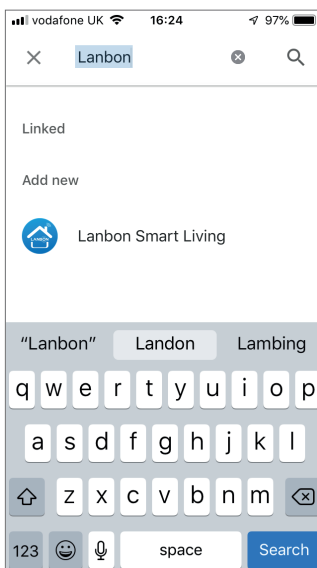

6) Login with your lanbon credentials.

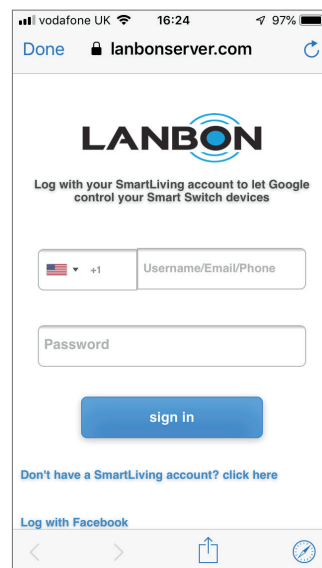

7) You will see the message "Lanbon Smart Living is now linked".

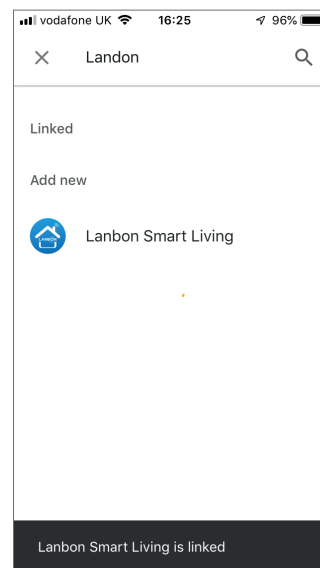

8) Now you can assign the smart WIFI switch to a room and start using with Google Home.

You can say "Hey Google, turn on the light" or "turn on bedroom light" if you have assigned the switch to the bedroom.

For more information how to use voice commands please refer to the Google Home user manual.

# Smart WIFI switch

3 Gang

# INTALED

## Connecting the smart WIFI switched to Amazon Alexa.

Note! Make sure you have paired smart WIFI switch with the mobile app.

- 1) Open the Alexa app on your smartphone and go to Skills & Games.
- 2) In the top right corner Search for the “Lanbon Smart Living” skill and enable.
- 3) Login with your Lanbon credentials.
- 4) You have now linked Amazon Alexa with Lanbon.

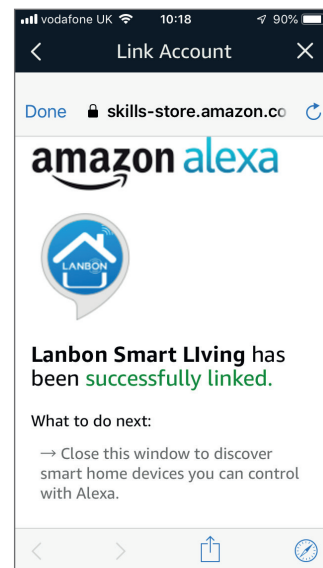
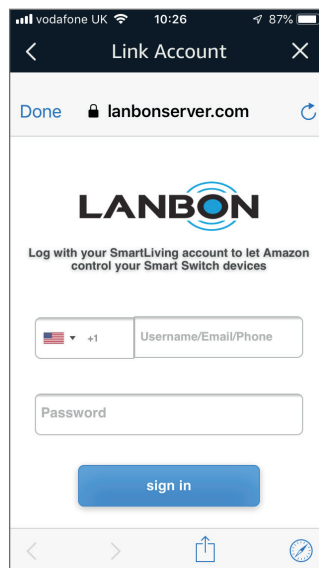
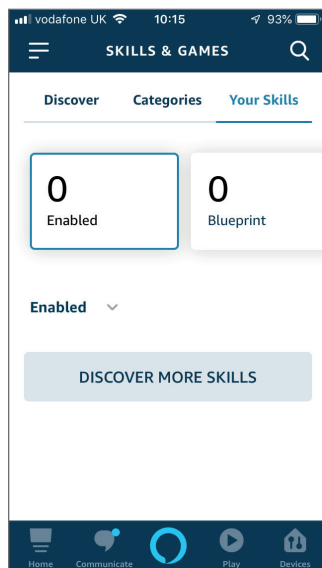
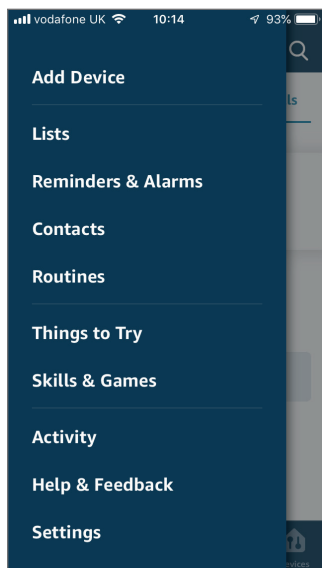

You can say “Alexa, turn on the light” or “turn on bedroom light” if you have assigned the name to “Bedroom Light”.

For more information how to use voice commands please refer to the Amazon Alexa user manual.

# Smart WIFI switch

3 Gang

# INTALED

Problem	Cause	Corrective
Unable to switch ON/OFF (No indicator light)	<ul style="list-style-type: none"><li>• No power.</li><li>• Wrong connection or unsecure connection.</li></ul>	<ul style="list-style-type: none"><li>• Check the power.</li><li>• Check the connection.</li></ul>
Cannot connect switches to WIFI	<ul style="list-style-type: none"><li>• Trying to connect to 5Ghz (802.11ac)</li></ul>	<ul style="list-style-type: none"><li>• Connect to 2.4GHz home network (802.11b/g/n)</li></ul>

## Safety

- Products must be installed and serviced by qualified electrician.
- Never install product whilst connected to power and double check connections before switching on to avoid short circuits.
- Ensure all terminal screws are fully tightened and product is securely fixed to its mounting box prior to turning on the mains supply.

## Guarantee:

All LED and electrical components carry a 5 year electrical guarantee, All lamps have their own average life span. We recommend all products are installed by NICEIC / registered electrical contractors, failure to do so will result in any guarantee becoming void.

## Full Terms & Conditions:

For our full terms and conditions please visit our website - [www.intalite.co.uk/terms-conditions](http://www.intalite.co.uk/terms-conditions)

INTALITE UK  
148 - 154 Merton High Street;  
London, SW19 1AZ, UK  
Tel: +44 (0)20 8542 1471  
Fax: 0870 4211 763  
[www.intalite.co.uk](http://www.intalite.co.uk)  
[sales@intalite.co.uk](mailto:sales@intalite.co.uk)